

Control Relays

Selection / Dimensions



TCA2DN..-XX



TCA3DN..-XX

Control Relays (AC)		
Contacts		Catalog Number
NO	NC	
2	2	TCA2-DN22-XX
3	1	TCA2-DN31-XX
4	0	TCA2-DN40-XX

Replace XX with voltage code from table - 7

Table - 7: XX-AC Coil Voltages																
Volts AC	24	48	110	120	208	220	230	240	277	380	400	415	440	480	575	600
50 Hz	B5	E5	F5			M5	P5	U5		Q5	V5	N5	R5			
60 Hz	B6	E6	F6	G6	L6	M6		U6	W6	Q6			R6	T6	S6	X6
50/60 Hz	B7	E7	F7	G7		M7	P7	U7		Q7	V7	N7	R7			

Control Relays (DC)		
Contacts		Catalog Number
NO	NC	
2	2	TCA3-DN22-XX
3	1	TCA3-DN31-XX
4	0	TCA3-DN40-XX

Replace XX with voltage code from table - 8

Table - 8: XX-DC Coil Voltages									
Volts DC	12	24	48	72	110	125	220	250	440
	JD	BD	ED	SD	FD	GD	MD	UD	RD

Independent Mounting

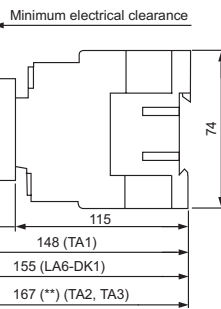
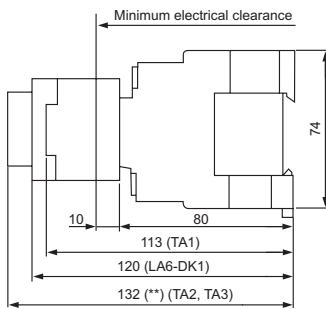

Panel Mounting

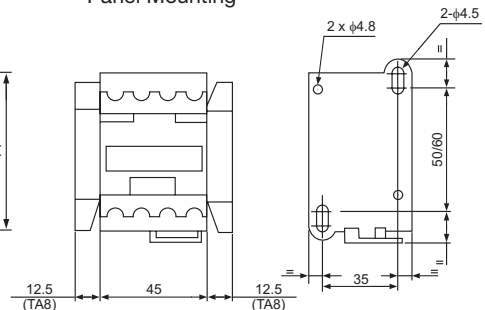

** + 4mm with lead sealing kit

AC Supply categories AC-14 & AC-15

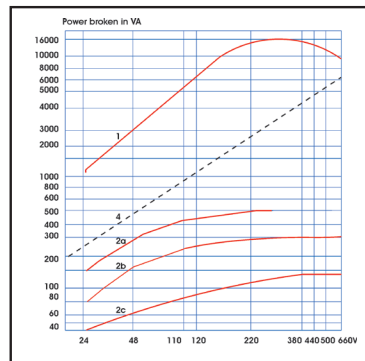

DC Supply categories DC-13

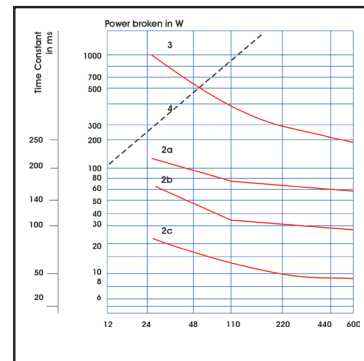

Control Relays

Environment				
Type			TCA2DN	TCA3DN
Conforming to Standards			IEC 60947-1, 60947-5, VDE 0660	
Approvals			UL, CSA	
Degree of Protection	Protection against direct finger contact		Conforming to VDE 0106	
Ambient air Temperature around the device	Storage	°C	-40...+80	
	Operation	°C	-5...+55	
	Permissible for operation at Uc	°C	-25...+70	
Maximum operating altitude	Without derating	m	3000	
Operating positions	Without derating		±30° possible, in relation to normal vertical mounting plane	
Shock Resistance	Control relay open		10g	8g
	Control relay closed		12g	11g
Vibration Resistance	Control relay open		5g	2g
	Control relay closed		10g	3g
Cabling	Flexible or solid cable with or without cable end	mm ²	Min: 1x1;	Max.: 2x2.5

Control Circuit Characteristics				
Type			TCA2DN	TCA3DN
Rated Insulation Voltage (Ui)	Conforming to IEC 947-1 & IEC 947-5	V	690	
	Conforming to CSA C22-2 no. 14	V	600	
Rated control circuit voltage (Uc)		V	12...600	
Permissible voltage variation	Operational		With 50 or 60 Hz coil: 0.8 ... 1.1 Uc With 50/60Hz coil: 0.85 ... 1.1 Uc	With standard Hz coil: 0.85 ... 1.1 Uc With wide range coil: 0.7 ... 1.25 Uc
Voltage limits	Drop-out		0.3 .. 0.6 Uc	0.1 .. 0.65 Uc
Average consumption at 20°C	- 50 Hz	VA	Inrush: 60, Sealed:7	-
	- 60 Hz	VA	Inrush: 70, Sealed:7.5	-
	- 50/60 Hz	VA	Inrush: 70, Sealed:8	-
	With standard coil	W	-	Inrush or Sealed: 9
	With wide band coil	W	-	Inrush or Sealed: 11
Operating Time (at rated control circuit voltage and at 20°C)	Between coil energisation and opening of the NC contacts	ms	6...20	35...43
	- closing of the NO contacts	ms	12...22	40...48
	Between coil de-energisation and opening of the NO contacts	ms	4...12	6...14
	closing of the NC contacts	ms	6...17	11...19
Short supply failures	Max. duration without affecting hold-in of device	ms	2	2
Maximum operating rate	In operating cycles per second		3	3
Mechanical Life at Uc (mechanical durability)	In millions of operating cycles With: 50 or 60 Hz coil		20	-
	50/60 Hz coil (at 50 Hz)		30	-
	Standard coil		-	30
	Wide band coil		-	30

Operating Power of Contactor with AC Supply categories AC-14 & AC-15

Electrical life (upto 3600 operating cycles/hr) on an inductive load such as the coil of an electromagnet: making power (cosΦ 0.7) - 10 times the power broken (cos Φ 0.4)

	V	24	48	110/127	220/230	380/400	440	600
1 million operating cycles	VA	150	300	400	480	500	500	500
3 million operating cycles	VA	80	170	250	290	320	320	320
10 million operating cycles	VA	30	65	90	120	130	130	130
Occasional making capacity	VA	1200	2600	7000	13000	15000	13000	9000

1. Breaking limit of contacts valid for maximum of 50 operating cycles at 10s intervals(breaking power=making power x cos Φ 0.7)
2. Electrical life of Contacts: for 1 million operating cycles (2a); for 3 million operating cycles (2b); for 10 million operating cycles (2C)
4. Thermal limit

Operating Power of Contactor with DC Supply categories DC-13

Electrical life (upto 1200 operating cycles/hr) on an inductive load such as the coil of an electromagnet without economy resistor, the time constant increasing with the power.

	V	24	48	110	220	440	600
1 million operating cycles	VA	120	90	75	68	61	58
3 million operating cycles	VA	70	50	38	33	28	27
10 million operating cycles	VA	25	18	14	12	10	9
Occasional making capacity	VA	1000	700	400	260	220	170

2. Electrical life of Contacts: for 1 million operating cycles (2a); for 3 million operating cycles (2b); for 10 million operating cycles (2C)
3. Breaking limit of contacts valid for maximum of 20 operating cycles at 10s intervals and with current passing for 0.5s per operating cycle.
4. Thermal limit

Control Relays

Synopsis - Contactors / Control Relays

Conforming to
IEC-VDE-BS-IS

For other standards, please refer to us

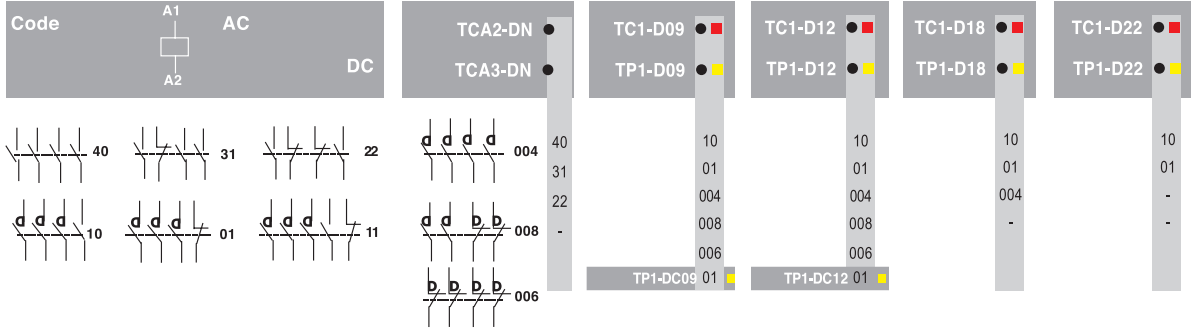

Maximum rated operational voltage	
Maximum rated current for motor control 3 phase 440V,50-60Hz for AC3 Duty)	
Maximum standard power rating for motor control for AC3 Duty $\theta < 55^{\circ}\text{C}$, 415V	
230V HP 460/480V HP UL-Continuous Current	3 phase AC3
	575/600V HP
	Mounting position (w.r.t. normal vertical mounting plane)*
Maximum terminal current I _{th} ($\theta < 40^{\circ}\text{C}$)	
Maximum operating rate (operations / hr)	
Average coil consumption (inrush / sealed)	
TP1-D TP1-DC	TC1-D 50 Hz 60 Hz 50/60 Hz DC
Power dissipation per pole at	
Mechanical life (in millions of operations)	
Power contact terminal capacity mm ²	
Overall dimensions in mm	
Projection (TCA2-D/TC1-D/TP1-DC)	
Over-all dimensions in mm	
Projection (TCA3-D/TP1-D)	
Weight (TC1-D/TP1-D/TP1-DC)	
Weight (TCA2/TCA3)	

660V	690V	690V	690V	690V
AC 15 duty (IEC 60947-5-1) AC 11 duty (IEC 851) 6A at 500V	9A	12A	18A	22A
	Kw / hp	Kw / hp	Kw / hp	Kw / hp
	4 / 5.5	5.5 / 7.5	9 / 12.5	11 / 15
-	2	3	5	-
-	5	7.5	10	-
-	7.5	10	15	-
+ 30 °	+ 30°	+ 30°	+ 30°	+ 30°
10A	25A	25A	32A	32A
10800 3600	3600 3600	3600 3600	3600 3600	3600 3600
60 / 7 VA 70 / 7.5 VA 70 / 8 VA 9 / 9W	60 / 7 VA 70 / 7.5 VA 70 / 8 VA 9 / 9W 150 / 2.75W	60 / 7 VA 70 / 7.5 VA 70 / 8 VA 9 / 9W 150 / 2.75W	60 / 7 VA 70 / 7.5 VA 70 / 8 VA 9 / 9W	60 / 7 VA 70 / 7.5 VA 70 / 8 VA 9 / 9W
1.56W 0.20W	1.56W 0.20W	1.56W 0.36W	2.5w 0.80W	1.56W 0.80W
30 20	20 15/15	20 15/15	20 15/-	20 15/-
30	30	30	30	30
2.5	4	4	6	6
80mm	80mm	80mm	85mm	85mm
115mm	115mm	115mm	120mm	120mm
	0.32/0.58/0.32	0.32/0.60/0.32	0.35/.85/-	0.35/0.85/-
0.32/0.58				

		Coil Selection Chart																				
For Contactor Type	Coil Reference	Volts →	Replace with ■ or ■ following codes																			
			12	24	48	72	110	120	125	208	220	230	240	250	277	380	400	415	440	480	575	600
TC1-D09-22	TX1-D2 ■	50 Hz		B5	E5										M5	P5	U5					
TC1-D25-38	TX1-D4 ■	60 Hz		B6	E6			F6	G6		L6			M6	P6	U6		W6	Q6	V5	N5	R5
TC1-D40-95	TX1-D6 ■	50/60 Hz		B7	E7			F7	G7					M7	P7	U7			Q7	V7	N7	R7
TP1-D09-22	TX4-D2 ■			BD	ED	SD	FD			GD				MD	PD		UD		QD	VD	ND	RD
TP1-D25-38	TX4-D4 ■			BD	ED	SD	FD			GD				MD	PD		UD		QD	VD	ND	RD
TP1-D40-80	TX4-D6 ■			BD	ED	SD	FD			GD				MD	PD		UD		QD	VD	ND	RD
TP1-DC09-12	TX4-DC2 ■			BD	ED		FD							MD								
TP1-DC25	TX4-DC4 ■			BD	ED		FD							MD								

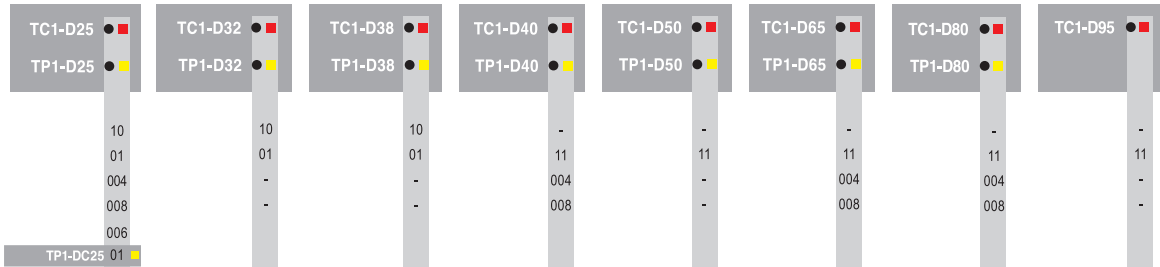

690V	690V	690V	690V	690V	690V	690V	690V
25A	32A	38A	40A	50A	65A	80A	95A
Kw / hp	Kw / hp	Kw / hp	Kw / hp	Kw / hp	Kw / hp	Kw / hp	Kw / hp
11 / 15	15 / 20	18.5 / 25	22 / 30	25 / 35	37 / 50	45 / 60	45 / 60
7.5	10	-	10	15	20	25	25
15	20	-	30	40	50	60	60
20	25	-	30	40	50	60	60
+ 30°	+ 30°	+ 30°	+ 30°	+ 30°	+ 30°	+ 30°	+ 30°
40A	50A	50A	60A	80A	80A	125A	125A
3600 3600	3600 3600	3600 3600	3600 3600	3600 3600	3600 3600	3600 3600	3600 3600
90 / 7.5VA 100 / 8.5 VA 100 / 8.5 VA 11/11W [250 / 3.5W]	90 / 7.5VA 100 / 8.5 VA 100 / 8.5 VA 11/11W	90 / 7.5VA 100 / 8.5 VA 100 / 8.5 VA 11/11W	200 / 20 VA 200 / 22 VA 245 / 26 VA 22 / 22W	200 / 20 VA 200 / 22 VA 245 / 26 VA 22 / 22W	200 / 20 VA 200 / 22 VA 245 / 26 VA 22 / 22W	200 / 20 VA 200 / 22 VA 245 / 26 VA -	200 / 20 VA 200 / 22 VA 245 / 26 VA -
3.2W 1.25W	5W 2W	5W 2W	5.4W 2.4W	9.6W 3.7W	6.4W 4.2W	12.5W 5.1W	12.5W 7.2
16 12/12	16 12/-	16 12/-	16 6/-	16 6/-	16 6/-	10 4/-	10 4/-
25	25	25	20	20	20	20	-
10	10	10	25	25	25	50	50
93mm	98mm	98mm	114mm	114mm	114mm	125mm	125mm
130mm	135mm	135mm	171mm	171mm	171mm	181mm	
0.505 / 0.88 / 0.505	0.525 / 0.88 / -	0.525 / 0.88 / -	1.15 / 2.1 / -	1.15 / 2.12 / -	1.15 / 2.16 / -	1.5 / 2.22 / -	1.5 / - / -