



Saves Your Energy

PRODUCT CARD

19.6.2013

SPCP131808T.U

Name: **Cubo S enclosure**
Size 125 x 175 x 75 mm, 50 mm base, plain sides, transparent cover, PC
Type: SPCP131808T.U
EAN: 6438100116392
Description: Ensto Cubo S is a series of small to medium size enclosures available with knockouts or plain sides. The base of the enclosures is equipped with unique slots for printed circuit boards.
Package: 25
Unit: PCS



Technical specification

Operating temperature (°C): - 40 °C... +80 °C
Short term temperature range: - 40 °C... +120 °C
Colour: RAL 7035
Content: Enclosure base, cover, cover screws, mounting screws
Material, base: Fiberglass reinforced polycarbonate
Material, cover: Polycarbonate
Material, cover screws: Polyamide
Material, gasket: Polyurethane
Weight (kg): 0,381
Inner depth (mm): 60,5
Outer base depth (mm): 50
Outer cover height (mm): 25
Size (mm): 125 x 175 x 75
Degree of protection: IP 66, IP 67
Environmental type UL: 4, 4X, 6, 12, 13
Flammability rating: UL 746C 5V
Impact strength: IK 08
Standard: EN 62208, UL 508A, GOST
UL File no.: E189312
UL category: NITW

Ensto Finland Oy

Ensio Miettisen katu 2
P.O.Box 77
06101 Porvoo, Finland

Tel. +358 204 76 21
Fax +358 204 76 2516

www.ensto.com

ID	Description	Date	By	Appr.
A				

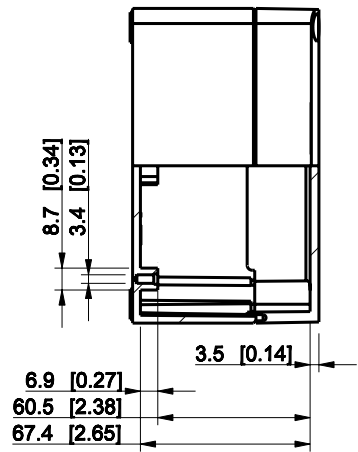
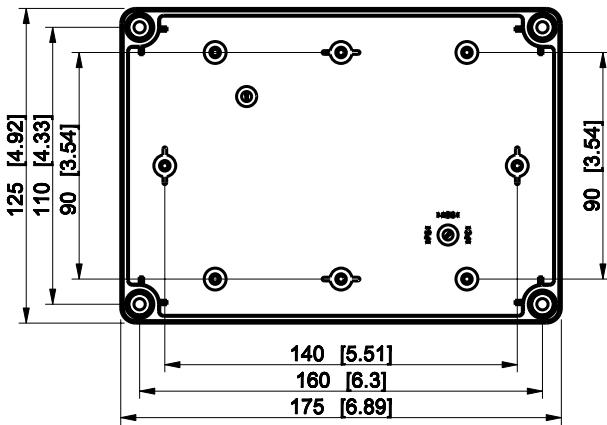
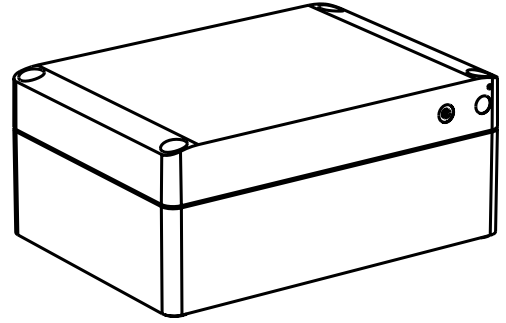
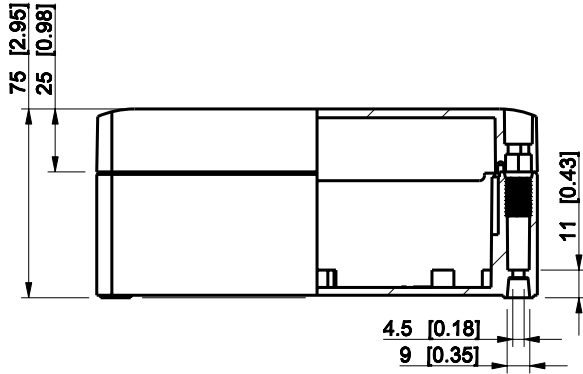

Dimensions in mm [inches]

Material: Polycarbonate, fiberglass-reinforced	Color: RAL 7035
--	-----------------

Supplier:	Tool No:	Weight [kg]: 0.34	Volume:
-----------	----------	-------------------	---------

ENSTO
ENSTO CONTROL OY

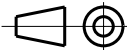

SPCP131808T

Scale	Date	08.12.08
1:3	By	PKos
-	Checked	
-	Ctrl	

Replaces:
Replaced:
Drw No: - A
Ref: Cubo S
Code: SPCP131808T
Sheet No:

model SPCP131808T PART

drawing CUBOS DRAWING