



Saves Your Energy

PRODUCT CARD

8.10.2013

OPCP304013T.U

Name: **Cubo O enclosure**
Size 300 x 400 x 132 mm, plain sides, transparent cover, PC
Type: OPCP304013T.U
EAN: 6438100117054

Description: Ensto Cubo O is a series of medium to large size enclosures available with plain sides or metric knockouts. Special features of the series allow mounting the cover onto the back of the base and include adjustable elevators for the base corner slots, enabling plates and panels to be mounted at any height.

Package: 1
Unit: PCS



Technical specification

Operating temperature (°C):	- 40 °C... +80 °C
Short term temperature range:	- 40 °C... +120 °C
Colour:	RAL 7035
Content:	Enclosure base, cover, cover screws, mounting screws
Material, base:	Fiberglass reinforced polycarbonate
Material, cover:	Polycarbonate
Material, cover screws:	Polyamide
Material, gasket:	Polyurethane
Volume cm ³ :	1584,00
Weight (kg):	2,199
Inner depth (mm):	115,0
Outer cover height (mm):	30
Size (mm):	300 x 400 x 132
Degree of protection:	IP 66, IP 67
Environmental type UL:	4, 4x, 12, 13
Flammability rating:	UL 746C 5V
Impact strenght:	IK 08
Standard:	EN 62208, UL 508A, GOST
UL File no.:	E189312
UL category:	NITW

Ensto Finland Oy

Ensio Miettisen katu 2
P.O.Box 77
06101 Porvoo, Finland

Tel. +358 204 76 21
Fax +358 204 76 2516

www.ensto.com

ID	Description	Date	By	Appr.
A				

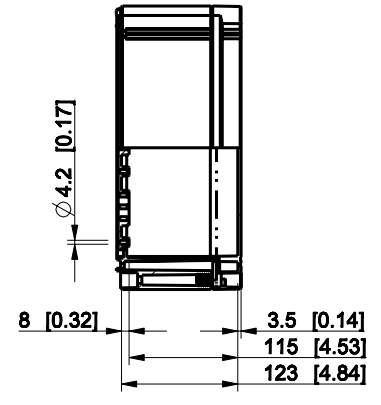
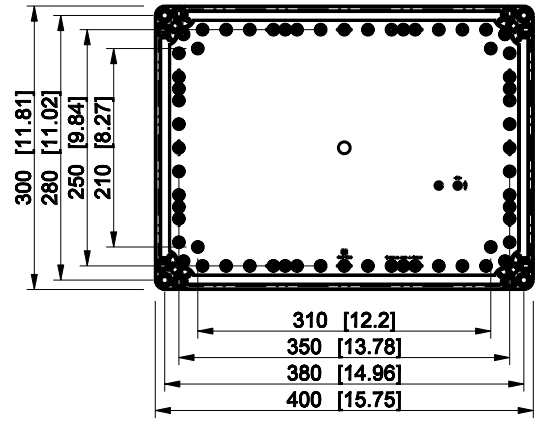
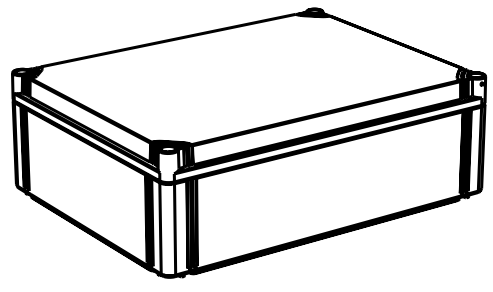
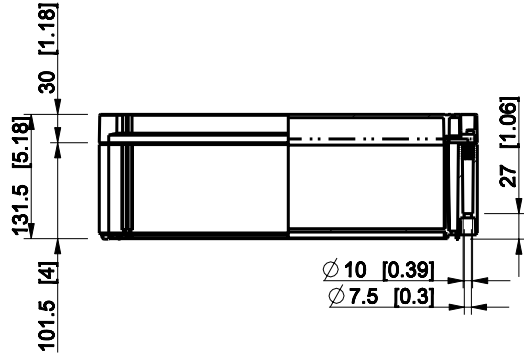

Dimensions in mm [inches]

Material: Polycarbonate, fiberglass-reinforced	Color: RAL 7035
--	-----------------

Supplier:	Tool No:	Weight [kg]: 2.18	Volume:
-----------	----------	-------------------	---------

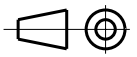

OPCP304013T

Scale	Date	18.12.08
1:8	By	PKos
-	Checked	
-	Ctrl	

Replaces:	
Replaced:	
Drw No:	A
Ref:	Cubo O
Code:	OPCP304013T
Sheet No:	

model OPCP304013T_PART
 drawing CUBO_O.drawing