

DIAMETRO FORATURA PANNELLO
PANEL DRILLING HOLE

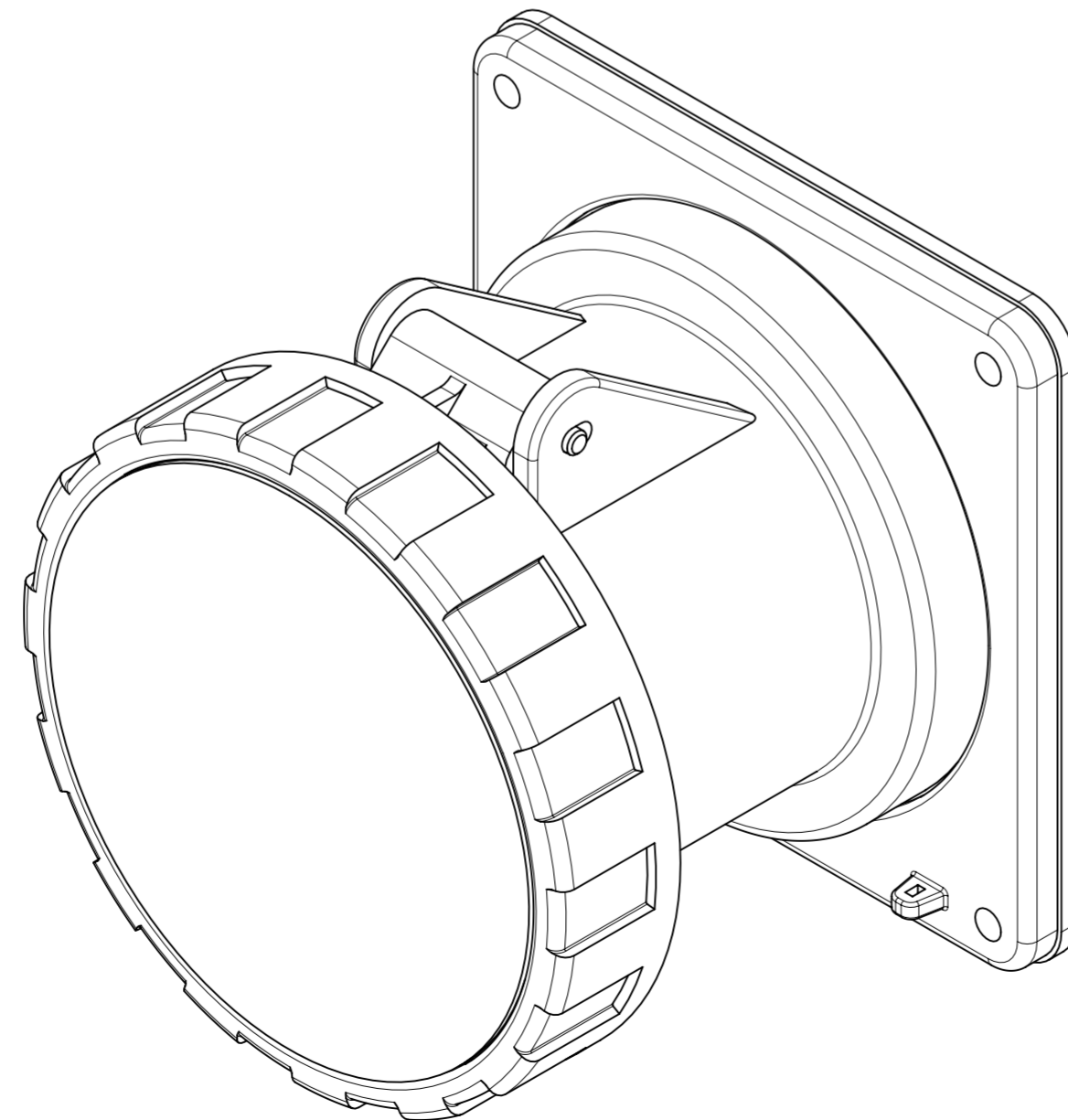
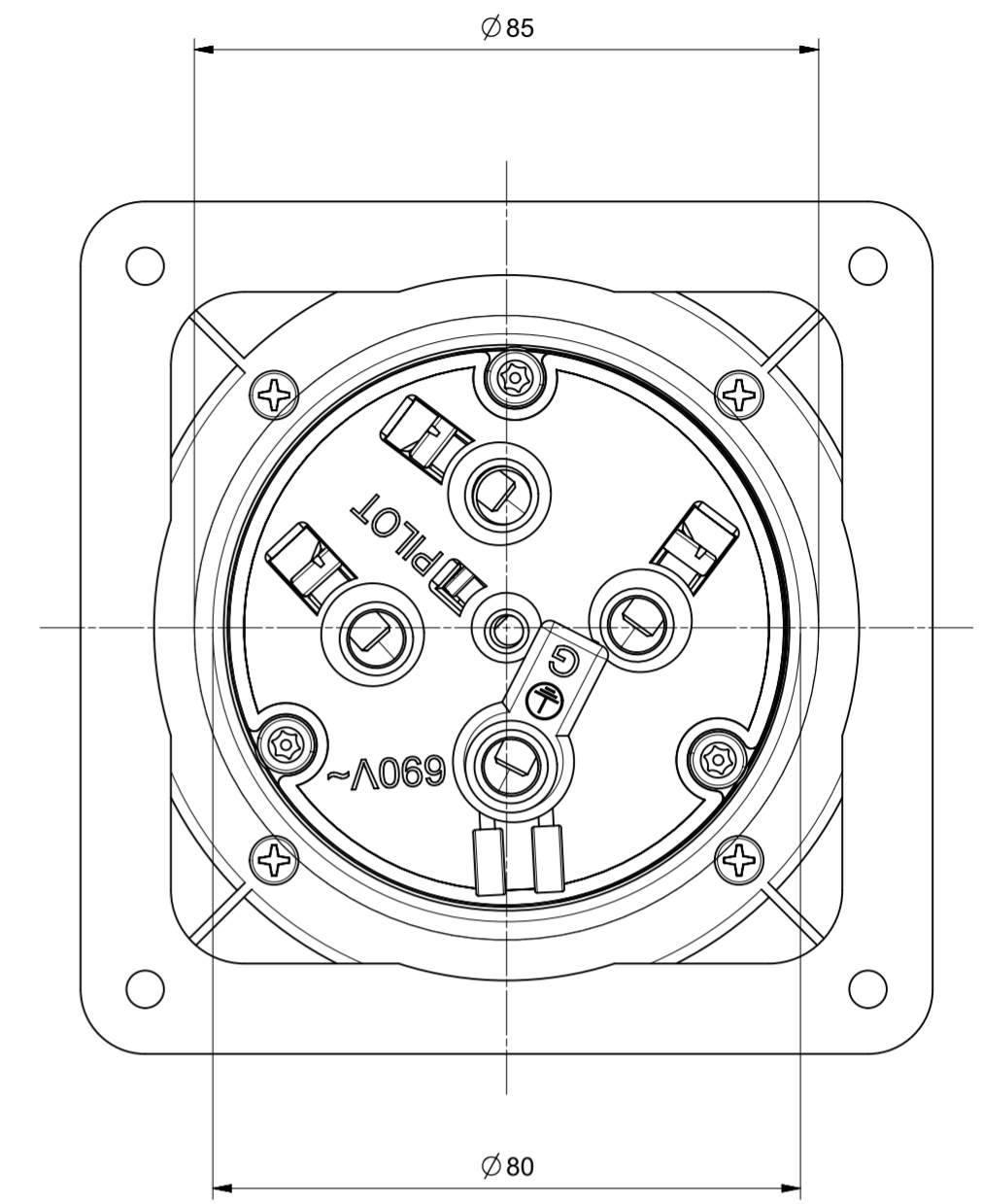

IL DISEGNO SI RIFERISCE ALLA POSIZIONE 6H
DWG REFERS TO CLOCK POSITION 6H

<p>At the end of the law, we reserve the ownership of this design may not be copied and transfer it to third parties or competitors</p> <p>SCAME S.p.A. PARRE - (Bergamo)</p>	Format	A2	Scale	1:1	Mould N°	1000XXXX	Drawn	SCAME	
	Tolerances for linear and angular dimensions without indication of specific tolerances: JS13 / UNI 286-1:2010							Date	
	DESCRIPTION							Approved	
PRESA PANNELLO 3P+T 63A IP67 UL							CODE	Sheet 1 / 1	
								4003610	