





Rating	4A 250V, 8A 125V  		Circuit Diagram	
	10A 125V.A.C., 1/3HP 125V.A.C.		OFF	
12A 14VDC, 6A 28VDC 	ON			
Contact Resistance			50m ohm Max.	
Insulation Resistance			DC 500V 100M ohm Min.	
Dielectric Strength	AC 1500V 1 minute			
Switch Function	2P SPST ON-OFF			

- 1 KNURL NUT ASSY
- 1 ON/OFF FACE PLATE ASSY
- 1 HEX NUT ASSY

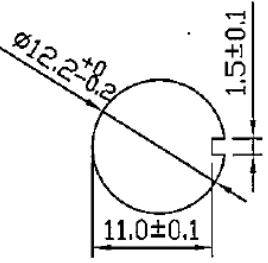
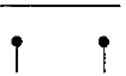
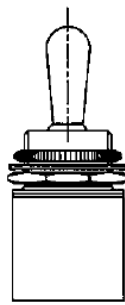
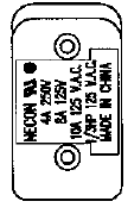
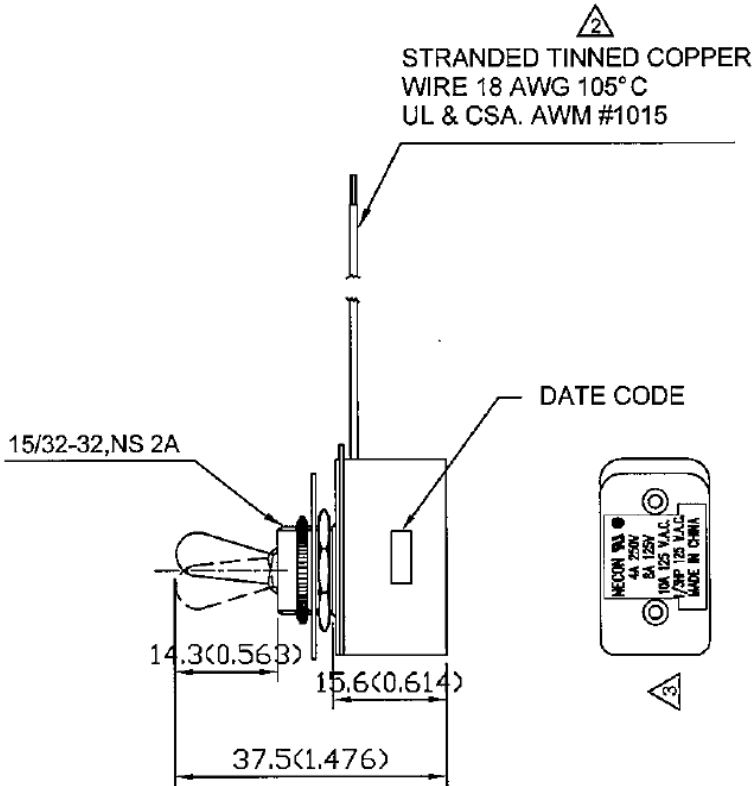
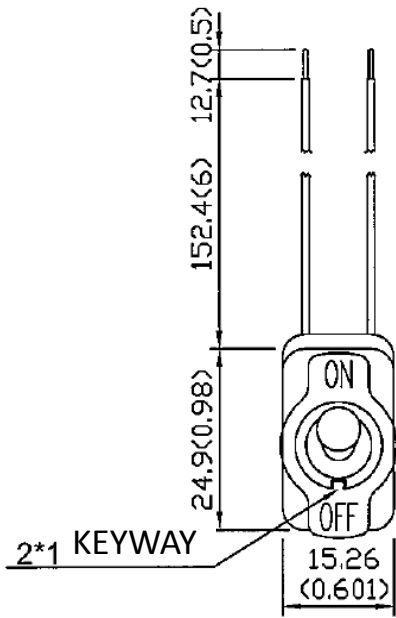

SINGLE POLE, SINGLE THROW